



Ceník a technická dokumentace
platnost: 1.1. 2025





Iron Dog 01

Uvedené ceny jsou bez DPH

	Položka č.	Počet	CZK
Iron Dog 01	50000		64171,50

Energetická třída A

	Položka č.	Počet	CZK
Žárovzdorný plech(zadní stěnu) pro Iron Dog 01	50130		3149,00



	Položka č.	Počet	CZK
Krabice pro připojení vzduchu			
Krabice pro připojení vzduchu	K006110		4991,50



	Položka č.	Počet	CZK
Roura aluflex			
Roura aluflex	N003054		1320,00



Iron Dog 02

Uvedené ceny jsou bez DPH

	Položka č.	Počet	CZK
Iron Dog 02	K007088		67169,00

Energetická třída A

	Položka č.	Počet	CZK
Žárovzdorný plech(zadní stěnu) pro Iron Dog 02	K007090		3217,50



Krabice pro připojení vzduchu	Položka č.	Počet	CZK
Krabice pro připojení vzduchu	K007101		5390,00



Roura aluflex	Položka č.	Počet	CZK
Roura aluflex	N003054		1320,00



Iron Dog 04

Uvedené ceny jsou bez DPH

	Položka č.	Počet	CZK
Iron Dog 04	50030		96277,50

Energetická třída A



	Položka č.	Počet	CZK
Krabice pro připojení vzduchu			
Krabice pro připojení vzduchu	K009160		6435,00



	Položka č.	Počet	CZK
Roura aluflex			
Roura aluflex	N003054		1320,00



Iron Dog 06 s funkcí grilu

Uvedené ceny jsou bez DPH

	Položka č.	Počet	CZK
Iron Dog 06	K011001		181747,50

Energetická třída A +



Příslušenství	Položka č.	Počet	CZK
Pečící plech	K011152		3424,00
Grilovací rošt (1 kus je součástí dodávky Iron Dog 06)	K011037		5321,50
Litínový pekáč smaltovaný ve dvou vrstvách	K011151		3712,50



Krabice pro připojení vzduchu	Položka č.	Počet	CZK
Krabice pro připojení vzduchu	K011155		5390,00



Roura aluflex	CZK	Počet	CZK
Roura aluflex	N003054		1320,00



Iron Dog 07

Uvedené ceny jsou bez DPH

	Položka č.	Počet	CZK
Iron Dog 07 Dvířka topeniště pravá	K012001-		106521,50
Iron Dog 07 Dvířka topeniště levá	03		106521,50

Energetická třída A +
K012001-04

Uvedené ceny jsou bez DPH



	Položka č.	Počet	CZK
Roura aluflex			
Roura aluflex	N003054		1320,00

Parametr	Iron Dog 01	Iron Dog 02	Iron Dog 04	Iron Dog 06	Iron Dog 07
Jmenovitý výkon (kW)	7	7	8	8	7
Spotřeba/h (kg)	2	2	2,2	2,5	2,2
Kapacita pro vytápění (m ²)	50-90	50-90	60-110	60-110	50-90
Energetický štítek / EEI	A / 106	A / 106	A+ / 107,5	A+ / 108,9	A+ / 108,9
Rozměry (v x š x h) (mm)	680x440x630	730x540x610	760x800x520	810x940x625	690x700x570
Plocha skleněné desky (v x š) (mm)	195x150	245x105	285x450	207x102	225x447
Otevření spalovací komory (v x š)	200x245	205x210	255x218	238x267	263x196
Pečící trouba (v x š x h) (mm)	---	---	---	270x300x415	---
Vývod kouřovodu	nahore/zadní	nahore/zadní	zadní	nahore/zadní	nahore/zadní
Průměr kouřovodu (mm)	130	130	150	130	150
Povolené množství paliva (kg)	1,5-2,5	1,5-2,5	1,5-2,5	2-3	1,5-2,5
Hloubka spalovací komory (cm)	40	40	60	45	49
Doporučená délka polen (cm)	25/33	25/33	33/50	25/33	25/33
Hmotnost z litiny (kg)	130	150	240	310	220
Spotřeba vzduchu pro spalování (m ³ /h)	15	15	18	18	18
Průměr připojení vzduchu (mm)	98	98	98	98	98
Požadované minimální vzdálenosti (cm):					
- K boční stěně	80	80	60	25	60
- K zadní stěně (bez izolačního panelu)	40	40	---	20	---
- K zadní stěně (s izolačním panelem)	30	30	30	---	25
- K přední straně	80	80	80	80	80
Schválení	EN 13240	EN 13240	EN 13240	EN 12815	EN 13240

IRON DOG[®]

EISERNER HUND[®]



Ein Hund ist treu, liebt die Nähe zum Menschen und freut sich, wenn jemand nach Hause kommt. Eisern, weil er hart ist und natürlich, weil er aus Gusseisen besteht.

Der »Eiserne Hund« hält ein Leben lang. Er ist ein Holzofen der besonderen Art. Finde deinen Typ. Jeder ist anders und einzigartig. Er wird dein Freund.

A dog is loyal, loves being close to people and is pleased when someone returns home. Iron because it is hard and natural because it is made of cast iron.

The »Iron Dog« stays with you for life. It is a special kind of wood-fired stove. Find your type. Each of them is different and unique. He will be your friend.

EISERNE HUNDE

sind Gussöfen made in Germany. Hergestellt von einem Familienbetrieb in der 3. Generation, der bis heute nur Holzöfen gebaut hat. In dieser Serie steckt all das Können und Wissen für einen außergewöhnlichen Ofen in außergewöhnlicher Qualität. Deshalb auch der außergewöhnliche Name »Eiserner Hund«.

Für außergewöhnliche Menschen oder als Geschenk an Freunde.

IRON DOGS

are cast iron stoves made in germany. They are manufactured by the 3rd generation of a family-owned company which has only manufactured wood-fired stoves right up to today.

This production comprises all of the skills and knowledge which is required for an extraordinary stove of an extraordinary quality. This is why they also have the extraordinary name »Iron Dog«.

For extraordinary people or as a gift for friends.

IRON DOG®

Das Lastenheft.
The specifications.

Produkt:	Kaminofen
<i>product:</i>	<i>chimney stove</i>
Brennstoff:	Holz
<i>fuel:</i>	<i>wood</i>
Design:	Gestaltung mit Designern und Künstlern
<i>design:</i>	<i>designed by designers and artists</i>
Name:	Aussagekräftig, einzigartig, international
<i>name:</i>	<i>meaningful, unique, international</i>
Material:	Gusseisen, 7 mm
<i>material:</i>	<i>cast iron, 7 mm</i>
Konstruktion:	Dichte Verschraubung, Verbindungstechnik Edelstahl
<i>construction:</i>	<i>tightly screwed connections, stainless steel thread</i>
Besonderheit:	Markante Form, einfache Bedienung, geringe Emission
<i>special feature:</i>	<i>good form, easy to use, low emission</i>
Produktionsort:	Deutschland

place of production: germany

Zielgruppe:	Menschen mit Anspruch an Form und Qualität
<i>target group:</i>	<i>people who demand form and quality</i>

Der Name »Eiserner Hund« - »Iron Dog« - ist als Marke eingetragen und geschützt.

The name »Eiserner Hund« - »Iron Dog« - is registered and protected as a trademark.

Zahlbar & Preiswert. *affordable & inexpensive*

Ein Holzofen muss bezahlbar sein.
Die Qualität spürbar.

*A wood-fired stove must be affordable.
The quality noticeable.*

Design: design.mattis, Darmstadt
Giesserei: Ortrander Eisenhütte
mit Präzisionsmaschinen bearbeitet
von Menschenhand montiert
26 Gussteile
3 Stahlwellen
65 Edelstahlschrauben
1 Glaskeramik

*Design: design.mattis, darmstadt
Foundry: ortrander eisenhütte
Manufactured using precision machines
assembled by humans
26 cast parts
3 steel shafts
65 stainless steel screws
1 glass ceramic*

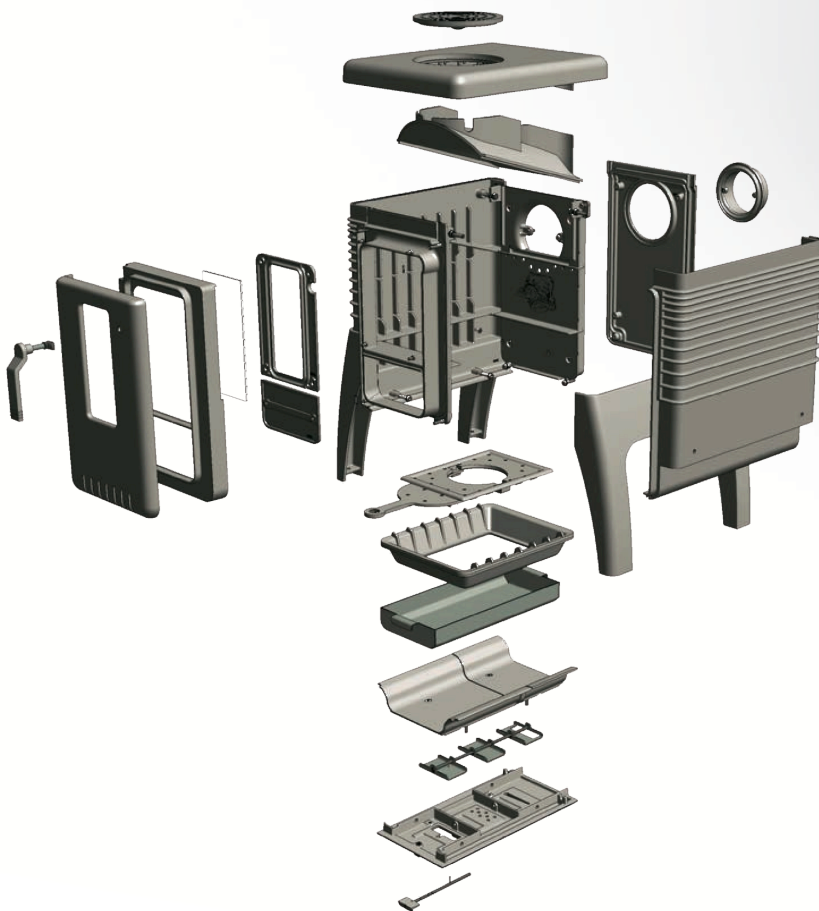



Iron Dog 01

IRON DOG® No 01

Ist alles im Leben technisch
abzusichern?

Wärme ist ein Grundbedürfnis.

Wer einen Holzofen besitzt, kann Kälte
besiegen - mit einfachsten Mitteln.

*Can everything in life be secured
by technical means?*

Warmth is a basic need.

*A person who owns a wood-fired stove
can conquer the cold - with the simplest
means.*

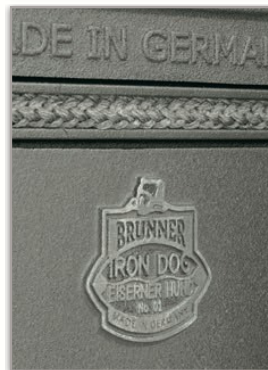

Fichte spruce





A

IRON DOG® No 02

Sind Gefühle wichtig?
Gefühle entscheiden alles.
Über Menschen, Situationen oder Produkte.

*Are feelings important?
Feelings decide everything.
About people, situations or products.*

10 | 11



Ahorn maple



A

IRON DOG® No 04

Können ein paar Holzscheite und
ein bequemer Sessel glücklich machen?
Zeit, Muse und Wohlbefinden sind durch nichts zu
ersetzen.

14 | 15

*Can a few logs and a comfortable armchair
make someone happy?
Time, muse and well-being cannot be replaced by
anything.*



Buche beech



A

IRON DOG® No 06

*Lebensfreude oder
Männerspielzeug?
Wärme und ein zufriedener Bauch.
Was immer es sein soll.*

*Life's joy or man's toy?
Warmth and a satisfied belly.
Whatever it should be.*

Kochmaschine *cooking machine*



Ahorn *maple*



A+

IRON DOG® No 07

Darf ein Holzofen so
zeitlos schlicht sein?
Reduktion ist die Kunst
der Gestaltung.

*Can a wood stove be
so simple and timeless?
Reduced design is a form of art.*

20 | 21



Birke *birch*



A+

IRON DOG® No 01

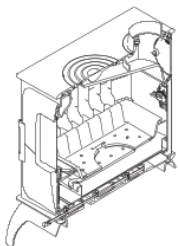
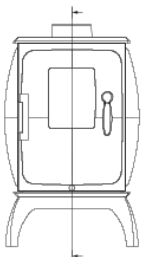
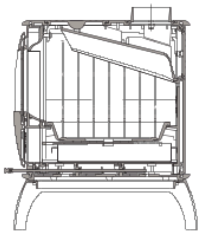
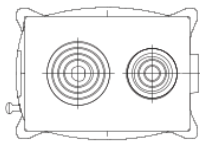
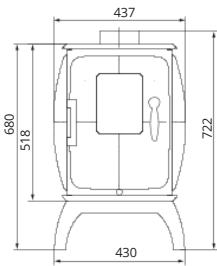
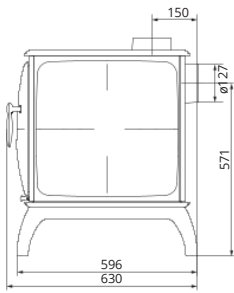

IRON DOG® No 02

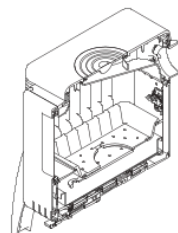
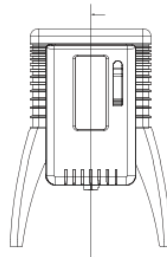
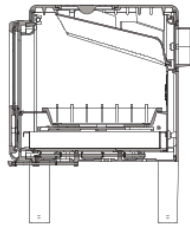
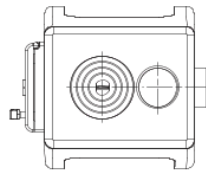
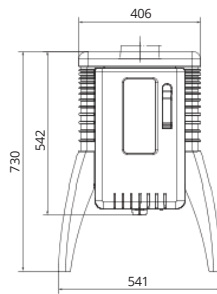
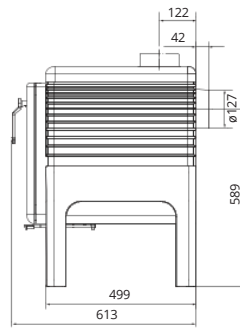

IRON DOG® No 04

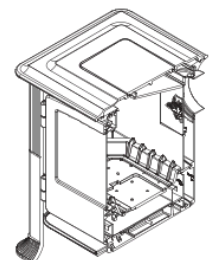
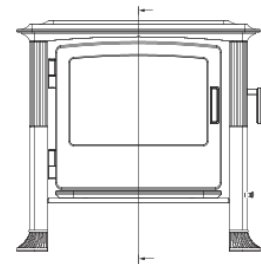
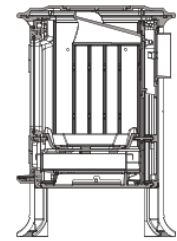
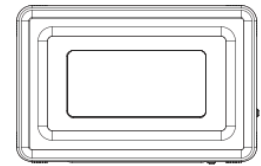
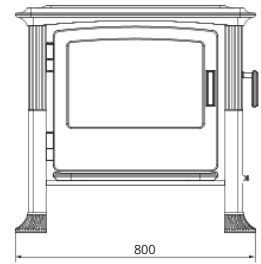
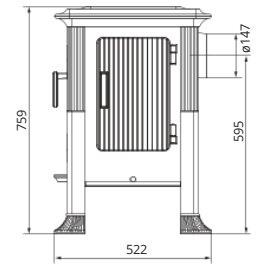

IRON DOG® No 06

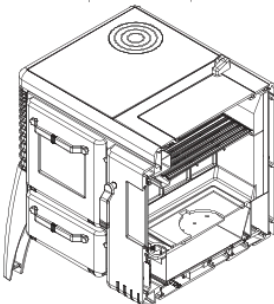
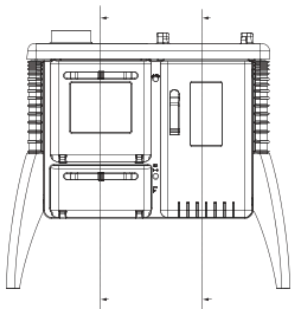
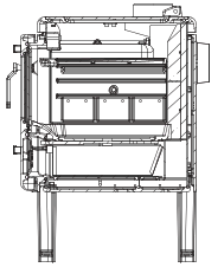
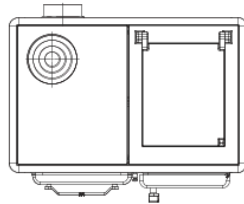
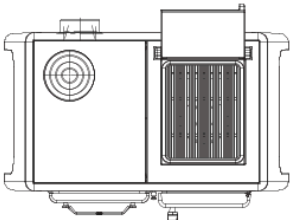
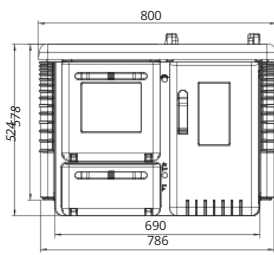
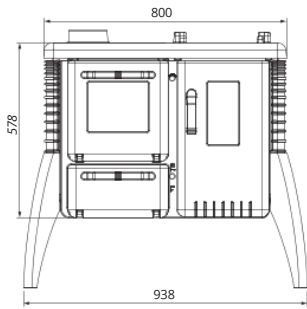
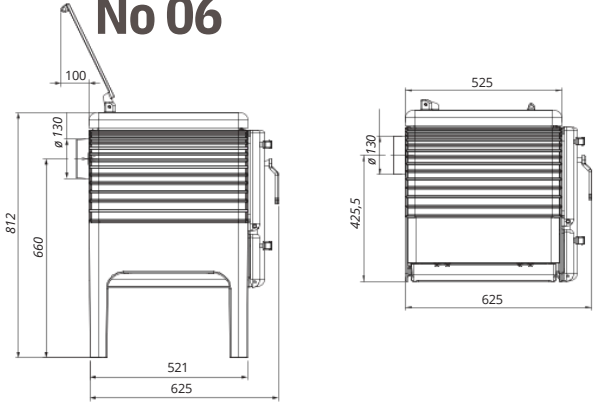

Zubehör:
Gussbräter, emailliert
*accessory:
casserole, enamelled*

Innenmaße:
internal dimensios:
360 x 285 mm



IRON DOG® No 07

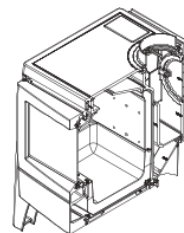
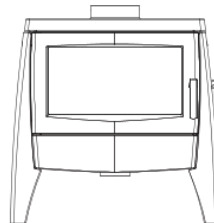
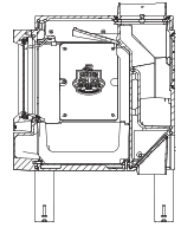
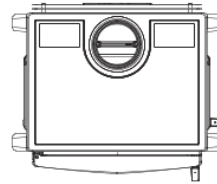
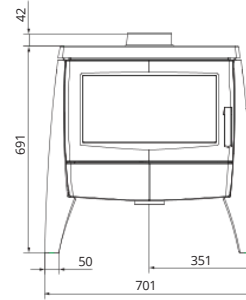
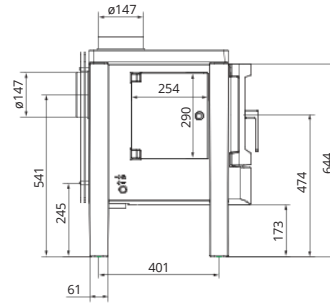

Technik. *technology.*

Eine ausgeklügelte Verbrennungsluftzuführung sorgt für eine langsame und gleichmässige Entgasung der Holzscheite bei geringsten Emissionen bzw. Verbrennungsrückständen. Die Primärluft \square strömt direkt in die Glutwanne und treibt sanft die Entgasung an. Die Sekundärluft \square hält die Glasscheibe sauber und durchmischt die Brenngase mit dem notwendigen Sauerstoff vor dem Flammkanal \square . Mit der Tertiärluft \square werden die im hinteren Bereich des Feuerraumes austretenden Gase zeitnah durchmischt und zur Zündreaktion gebracht.

Die Bedienung erfolgt mit einem einzigen Stellelement \square . Einfacher kann ein Holzofen nicht bedient werden. Der hohe Wirkungsgrad wird durch große Wärmeaufnahme­flächen in Kombination mit besonderen Heizgasumlenkungen erreicht.

A cleverly devised combustion air feed ensures a slow and constant degassing of the logs with the lowest possible emission and combustion residue respectively. The primary air \square flows direct into the embers pan and softly impels the degassing. The secondary air \square keeps the glass plate clean and thoroughly mixes the combustion gases with the required oxygen in front of the flame tube \square . The tertiary air \square promptly mixes the gases which are emitted at the rear part of the combustion chamber and these are then ignited.

The operation takes place with a single adjusting element \square . There is no easier way to use a wood-fired stove. The high degree of efficiency is achieved by means of large heat absorption surfaces in combination with special heating gas deflections.

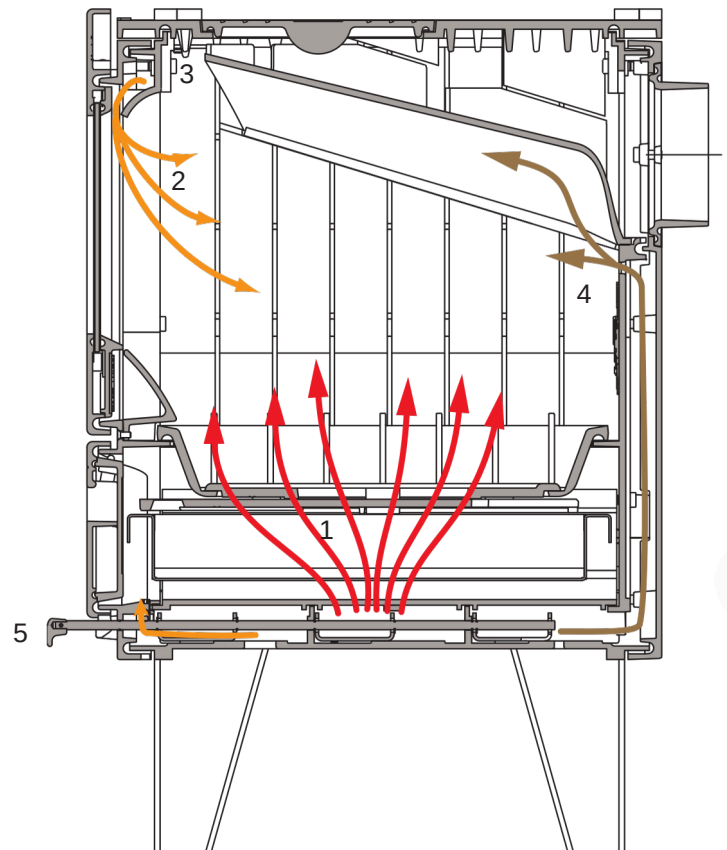



Iron Dog 07

Wir machen alles selbst. *Everything is our own work.*

Das klingt zwar etwas altmodisch und deutsch, hat sich aber bewährt.

Nur wenn man das Ganze kennt, hängt Seele und Stolz aller Mitarbeiter an einem Produkt. Und das spürt man.

Das beginnt mit der Konstruktion mit eigenen Ingenieuren und Technikern, geht weiter mit einem Prototyp im Prüflabor und der Fertigung in unserer eigenen Gießerei.

Montage und Kontrolle sind die letzten Handgriffe, bevor ein IRON DOG in die Kiste kommt.

Und gibt es einmal etwas zu verbessern, so machen wir das sofort und gerne. Schließlich ist es unser Produkt.

It might sound a little old-fashioned but it is proven and tested.

Only when everyone knows everything, does the soul and pride of all of our employees hang on a product, and one notices it.

It starts with the design which is carried out by our own engineers and technicians, continues with the prototype in the test laboratory, followed by our own foundry.

Work, assembly and inspection and the last finishing touches before an IRON DOG is packed.

If anything should have to be improved, we do so immediately and like doing it. It is our product after all.



Hubertus Brunner

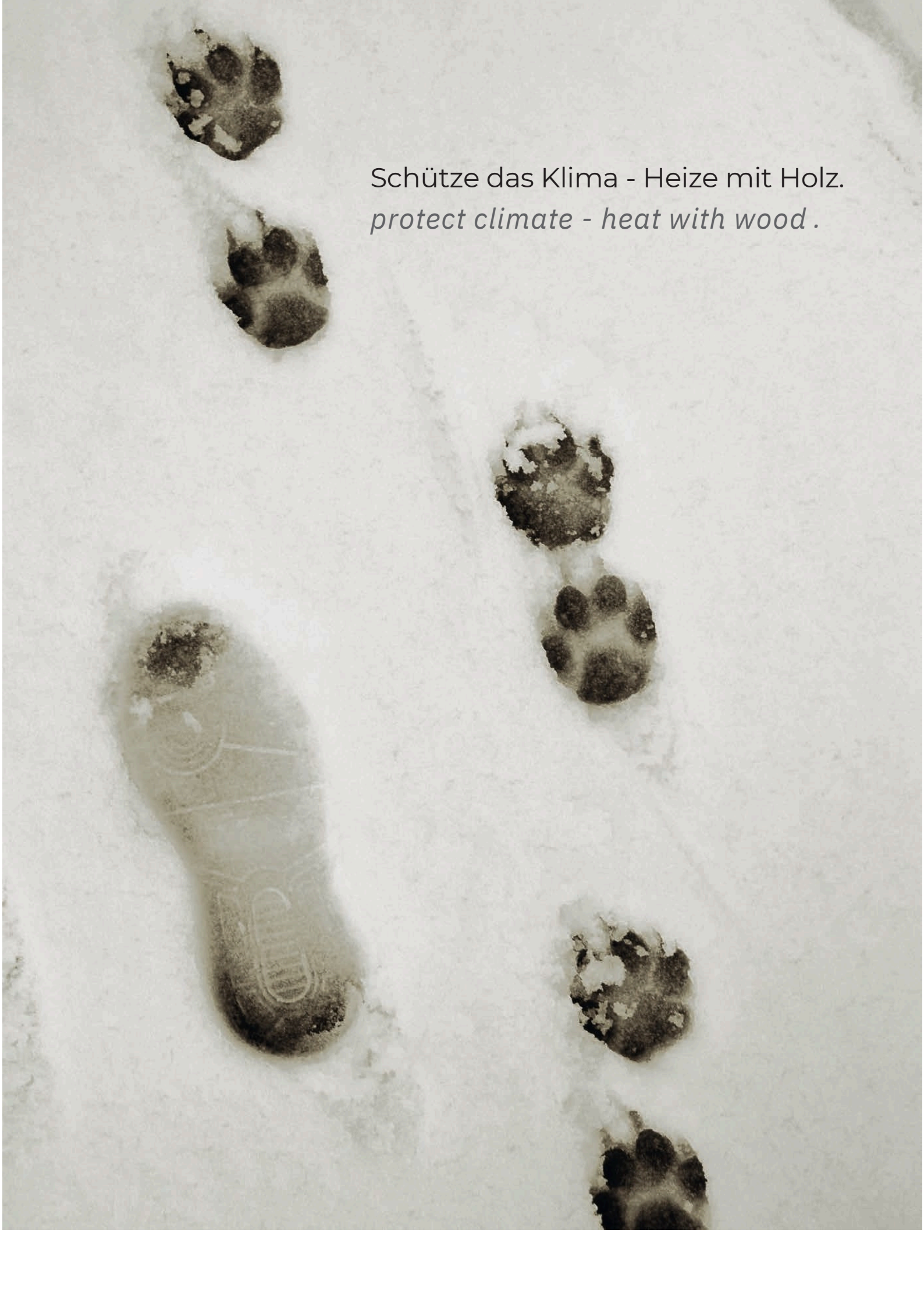

Parametr	Iron Dog 01	Iron Dog 02	Iron Dog 04	Iron Dog 06	Iron Dog 07
Jmenovitý výkon (kW)	7	7	8	8	7
Spotřeba/h (kg)	2	2	2,2	2,5	2,2
Kapacita pro vytápění (m ²)	50-90	50-90	60-110	60-110	50-90
Energetický štítek / EEI	A / 106	A / 106	A+ / 107,5	A+ / 108,9	A+ / 108,9
Rozměry (v x š x h) (mm)	680x440x630	730x540x610	760x800x520	810x940x625	690x700x570
Plocha skleněné desky (v x š) (mm)	195x150	245x105	285x450	207x102	225x447
Otevření spalovací komory (v x š)	200x245	205x210	255x218	238x267	263x196
Pečící trouba (v x š x h) (mm)	---	---	---	270x300x415	---
Vývod kouřovodu	nahore/zadní	nahore/zadní	zadní	nahore/zadní	nahore/zadní
Průměr kouřovodu (mm)	130	130	150	130	150
Povolené množství paliva (kg)	1,5-2,5	1,5-2,5	1,5-2,5	2-3	1,5-2,5
Hloubka spalovací komory (cm)	40	40	60	45	49
Doporučená délka polen (cm)	25/33	25/33	33/50	25/33	25/33
Hmotnost z litiny (kg)	130	150	240	310	220
Spotřeba vzduchu pro spalování (m ³ /h)	15	15	18	18	18
Průměr připojení vzduchu (mm)	98	98	98	98	98
Požadované minimální vzdálenosti (cm):					
- K boční stěně	80	80	60	25	60
- K zadní stěně (bez izolačního panelu)	40	40	---	20	---
- K zadní stěně (s izolačním panelem)	30	30	30	---	25
- K přední straně	80	80	80	80	80
Schválení	EN 13240	EN 13240	EN 13240	EN 12815	EN 13240

A photograph showing a large, light-colored boot print on the left side of a snowy surface. To the right of the boot print, there are several dark, paw-shaped prints arranged in a line, suggesting a path. The snow is bright white and appears soft. The boot print has some faint, embossed details on its sole, including a circular logo and some text that is difficult to read. The paw prints are dark brown or black, contrasting sharply with the white snow.

Schütze das Klima - Heize mit Holz.
protect climate - heat with wood .

made in germany.

IRON DOG[®]

EISERNER HUND[®]

IRON DOG ist ein Produkt der Ulrich Brunner GmbH, Eggenfelden
IRON DOG is a product of Ulrich Brunner GmbH, Eggenfelden, Germany
IRON DOG ist eine geschützte Marke.
IRON DOG is a registered trademark.

Ulrich Brunner GmbH
Zellhuber Ring 17 - 18 D-
84307 Eggenfelden
Germany Telefon: +49 8721
771-0 Telefax: +49 8721 771-
100
info@iron-dog.de www.iron-dog.de

IRON DOG wird ausschließlich vom qualifizierten Fachbetrieb angeboten und verkauft. Technische und sortimentsbedingte Änderungen sowie Irrtümer vorbehalten. Sämtliche Abbildungen können aufpreispflichtige Zusatzfunktionen bzw. Sonderausstattungen enthalten. Nachdruck und Vervielfältigung, auch auszugsweise, nur mit ausdrücklicher Genehmigung des Herausgebers.

IRON DOG is exclusively distributed by IRON DOG-Partners.

All products presented are subject to changes in technology, design and availability. All images may contain additional functions or special equipment that are subject to a surcharge. Reproduction and duplication, in whole or in part, only with the express permission of the publisher.

